



Installation Guide

Outdoor CPE

CPE210 / CPE220 / CPE510 / CPE520

Contents

Overview	01
Hardware Connection	04
Site Consideration	04
Connection and Installation	06
Lightning & ESD Protection	08
Software Configuration	10
Logging in to the PharOS	10
Typical Application Configuration	12
Antenna Alignment	14
Specifications	15
FAQ	16

Overview

TP-Link's Pharos series outdoor CPEs are dedicated to outdoor wireless network solutions. This guide is applicable to products including CPE210, CPE220, CPE510 and CPE520.

• Package Contents



Pharos CPE



Power Cord



Pole Mounting Straps

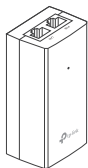

Passive PoE Adapter

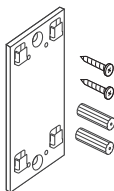

Mounting Bracket
Plastic Wall Anchors (Qty.2)
Self-tapping Screws (Qty.2)

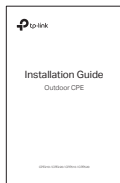

Installation Guide

• LED Explanation

The following picture takes CPE520 as an example.

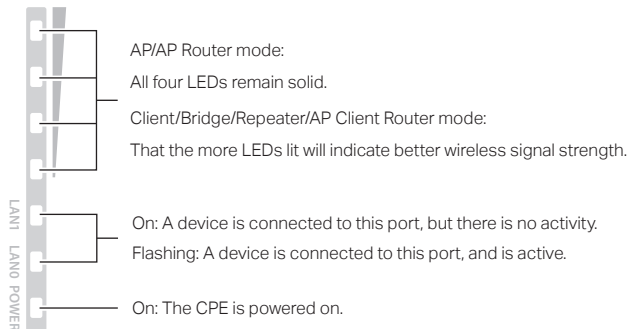

• Panel Layout

Pharos CPE220/CPE520:

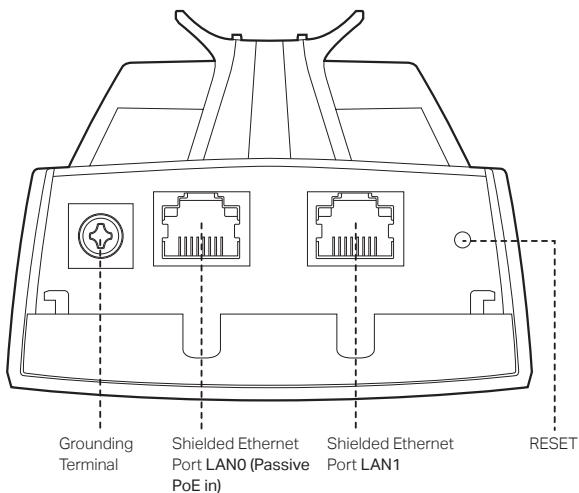

Pharos CPE210/CPE510:

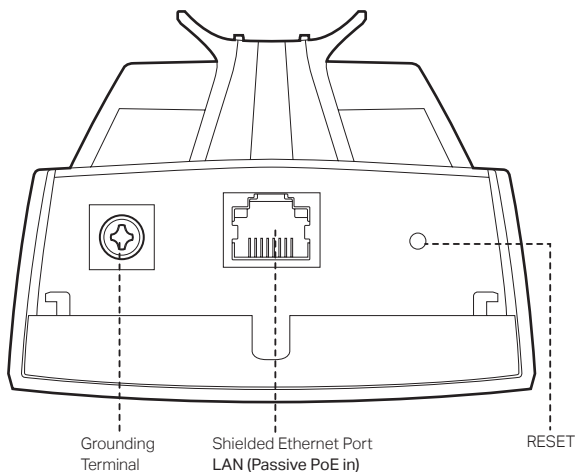

Passive PoE Adapter:

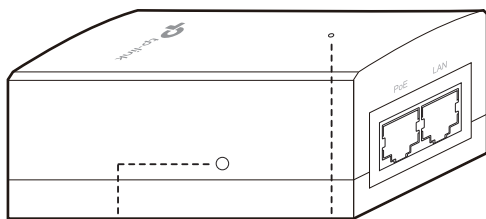

Remote Reset

Press and hold for 8 seconds to reset the CPE to its factory defaults.

Power LED

The Power LED is on when the passive PoE adapter is working normally.

Hardware Connection

1. Site Consideration

- Mounting Height

Ensure a clear line of sight between the wireless devices for an optimum performance. An elevated location is recommended as obstacles like trees, buildings and large steel structures will weaken the wireless signal.

See 'Q2' in 'FAQ' for details about how to calculate the minimum mounting height of the devices.

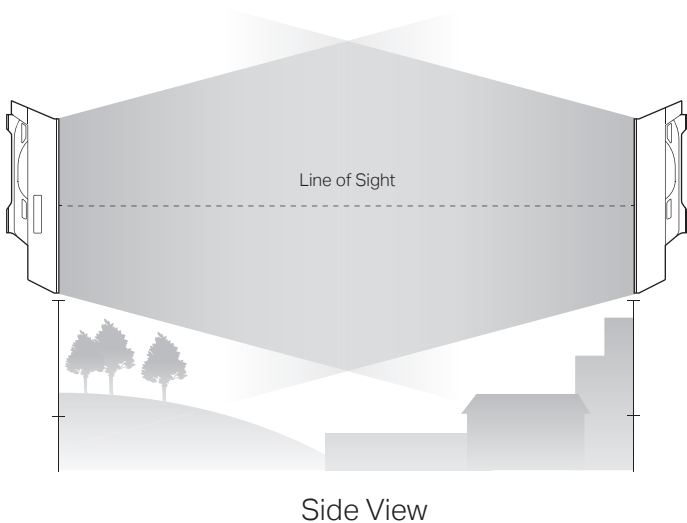

• Orientation

Install the CPE devices with the front facing the intended signal receiving devices. You can orient the devices with the assistance of Google Maps, GPS and some landmarks according to the horizontal beamwidth listed below.

Models	CPE210	CPE220	CPE510	CPE520
Horizontal Beamwidth	65°	60°	45°	45°



2. Connection and Installation

Connect and mount the CPE and power adapter as shown below. The following introduction takes CPE520 as an example.

• Connecting CPE and Power Adapter

Connect the CPE and power adapter as shown in the figure below.

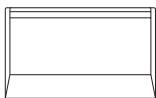
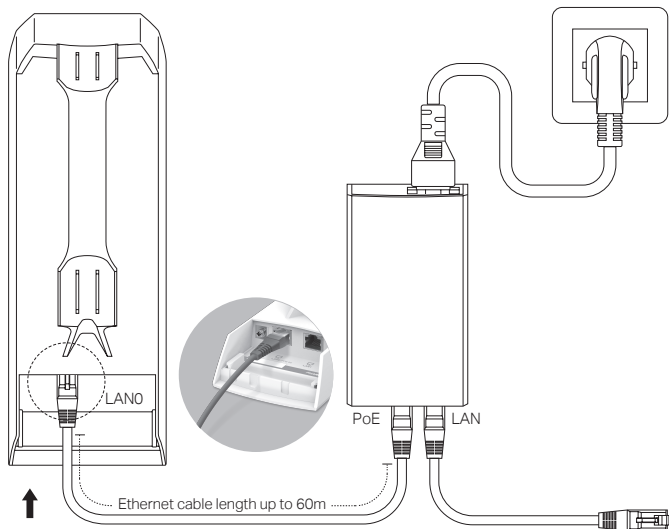

Slide to replace the cover of the CPE when all connections are finished.

You should prepare an adequate Ethernet cable to connect the CPE and the passive PoE adapter. Shielded CAT5e (or above) cable with ground wire is recommended (refer to the next section).

Connect to a computer, router or switch. (Depending on your intended usage and/or network topology.)

• Mounting CPE

At the selected site, approximately align the CPE to the direction that you have oriented.

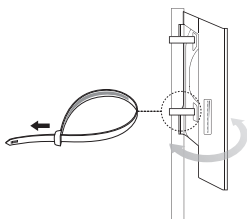

• Mounting Power Adapter (Optional)

Follow the steps below to mount the power adapter:

 To ensure the passive PoE adapter is attached most securely, it is recommended to install the adapter with the Ethernet port facing upward.

1. Drill two holes on the wall and insert the plastic wall anchors into the the holes. Secure the mounting bracket to the wall. Make sure the shoulders at the corners of the mounting bracket are on the outside and pointing upward.

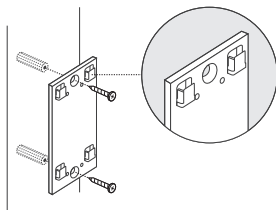

2. Attach the passive PoE adapter to the mounting bracket by sliding the adapter in the direction of the arrows until it locks into place.

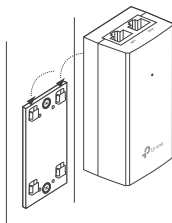

3. Lightning & ESD Protection

Proper grounding is extremely important for outdoor devices.

By using shielded CAT5e (or above) cable with ground wire for the connection and the provided PoE adapter (method ①), you can effectively eliminate ESD attacks. If you use the general CAT5e cable for the connection, then it is necessary to connect the grounding terminal of the CPE to earth ground through grounding cable (method ②).

The following introduction takes CPE520 as an example.

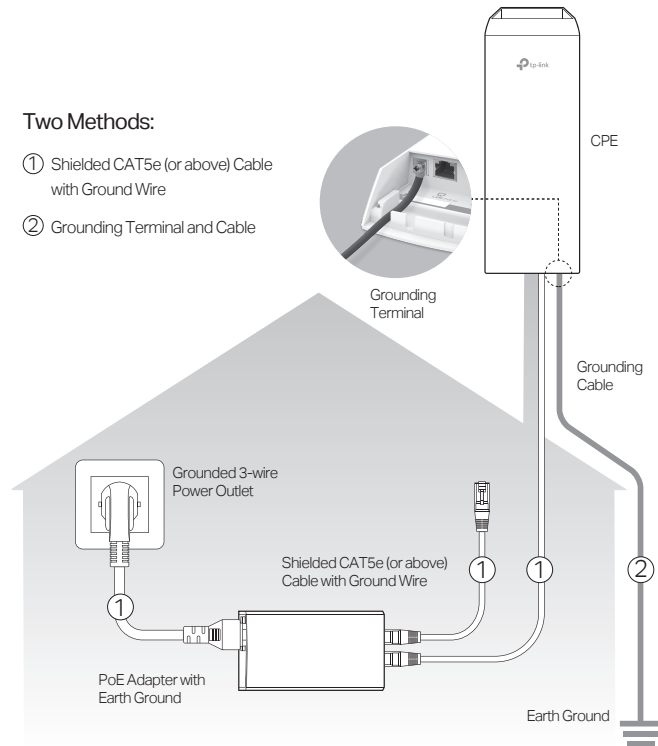

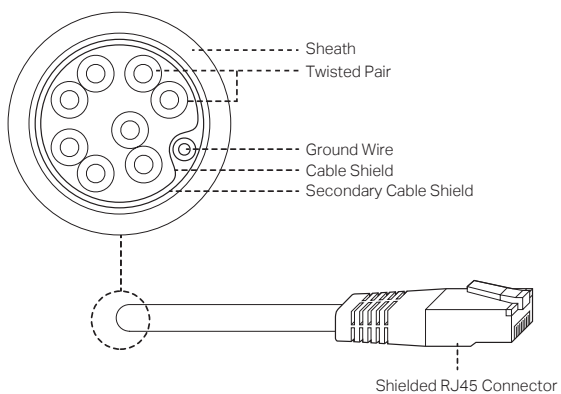

Shielded CAT5e (or above) Cable with Ground Wire

Software Configuration

This chapter introduces the login to the PharOS Web Interface and the software configurations.

1. Logging in to the PharOS

1. Before accessing the PharOS Web Interface, you need to assign a static IP address 192.168.0.X (X ranges between 2 and 253, e.g. 192.168.0.10) to your computer.

General

You can get IP settings assigned automatically if your network supports this capability. Otherwise, you need to ask your network administrator for the appropriate IP settings.

Obtain an IP address automatically

Use the following IP address:

IP address: 192 . 168 . 0 . 10

Subnet mask: 255 . 255 . 255 . 0

Default gateway: . . .

Obtain DNS server address automatically

Use the following DNS server addresses

Preferred DNS server: . . .

Alternate DNS server: . . .

Validate settings upon exit

Advanced...

OK Cancel

2. Open a web browser, type <http://192.168.0.254> into the address field and press **Enter** (Windows) or **return** (Mac). It is recommended to use the latest version of Google Chrome, Firefox or Safari.

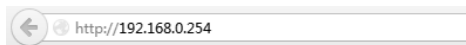

3. Enter **admin** for both **User Name** and **Password**. Read and agree the terms of use, then click **Login**.
4. Change the default User Name and Password to protect your CPE. Let's start configuring the CPE.

 For subsequent logins, use the new username and password.

For more configurations, please visit <http://www.tp-link.com/support> to download the User Guide of PharOS products in the download center.

2. Typical Application Configuration

The typical topology is as follows. A wireless bridge is built between two locations that are far from each other. Follow the instructions below to configure the Access Point and the Client.

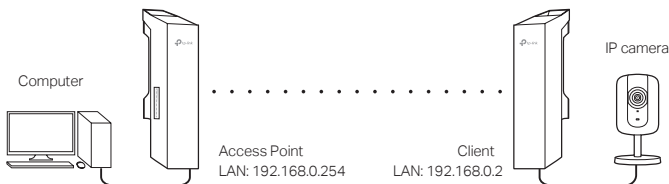

Configure the Access Point (AP)

1. Log in to PharOS and go to the Quick Setup page.
2. Operation Mode: Select **Access Point** and click **Next**.
3. LAN Settings: Click **Next**.
4. Wireless AP Settings:
 - a. Create a new SSID (Network name) for your wireless network.
 - b. Select **WPA-PSK/WPA2-PSK** for the Security method and create a PSK Password to protect your AP.
 - c. Enter the distance between the Access Point and the Client into the Distance Setting field.
 - d. Select the **MAXstream** checkbox (Refer to Q3 in FAQ for details about MAXstream), and click **Next**.
5. Finish: Verify your settings and click **Finish** to complete the configuration.

Configure the Client

1. Log in to PharOS and go to the Quick Setup page.
2. Operation Mode: Select **Client** and click **Next**.

3. LAN Settings: Change the IP Address to 192.168.0.X (X ranges between 2 and 253), the same subnet with the access point, and click **Next**.
4. Wireless Client Settings:
 - a. Click **Survey** and select the SSID of the Access Point in the AP list, then click **Connect**.
 - b. Select **WPA-PSK/WPA2-PSK** from the Security option, enter the same PSK password and distance value of the Access Point, then click **Next**.
5. Finish: Verify your settings and click **Finish** to complete the configuration.

For more configurations, please visit <http://www.tp-link.com/support> to download the User Guide of PharOS products in the download center.

Antenna Alignment

In order to get the best performance, you can precisely align the direction of the CPE with the assistance of Wireless Signal Quality on STATUS page of the PharOS Web Interface.

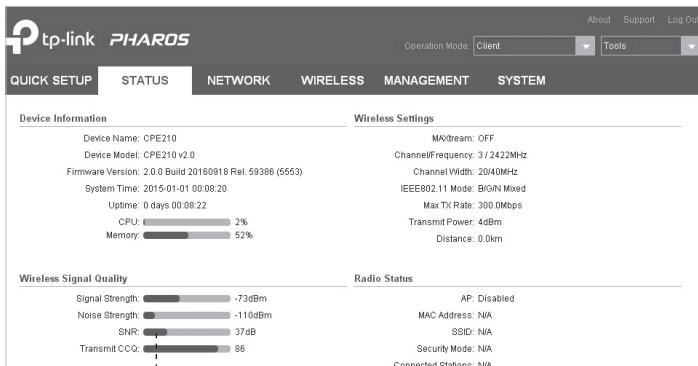

Adjust the direction of the CPE until the device reaches the highest SNR.

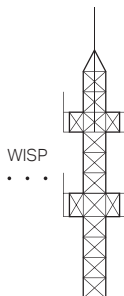
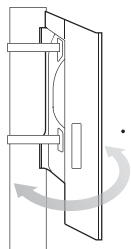
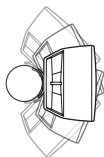

Specifications

HARDWARE FEATURES				
Dimensions	CPE520/CPE220: 275.83*79*60.3mm CPE510/CPE210: 224.34*79*60.3mm			
Interface	CPE520/CPE220	CPE510/CPE210		
	LAN0: 10/100Mbps Ethernet Port (PoE IN) LAN1: 10/100Mbps Ethernet Port	LAN: 10/100Mbps Ethernet Port (PoE IN)		
	GND: Grounding Terminal for Lightning Protection RESET: Button to restore the device to Factory Default			
Power Supply	24V Passive PoE Adapter Included			
ESD Protection ¹	15kV			
Lightning Protection ¹	Up to 6kV			
Operating Temperature	-40°C to 70°C (-40°F to 158°F)			
Operating Humidity	10% to 90%			
Certification	CE, FCC, RoHS, IP55			
WIRELESS FEATURES				
Models	CPE210	CPE220	CPE510	CPE520
Antenna Gain	9dBi	12dBi	13dBi	16dBi
Horizontal Beamwidth/Elevation Beamwidth ²	65°/ 35°	60°/ 30°	45°/ 30°	45°/ 30°
802.11 Standards	11b/g/n	11b/g/n	11a/n	11a/n

Note:

1. Estimation is based on copper grounding cable and shielded CAT5e cable with ground wire.
2. Beamwidth values may vary throughout operating frequency.

FAQ

Q1. How to restore the CPE to its factory default settings?

With the CPE powered on, press and hold the RESET button on the CPE or the Remote Reset button on the passive PoE adapter for about 8 seconds until the Wireless Signal Strength LEDs flash.

Method 1:

The following picture takes CPE520 as an example.

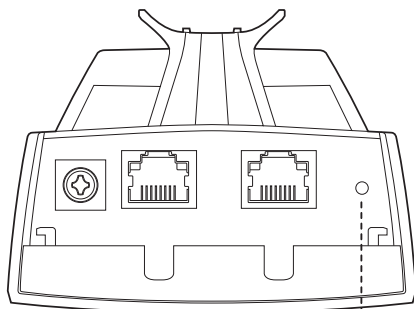

RESET Button

Press & hold for about 8 seconds

Method 2:

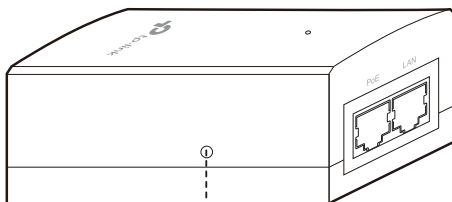

Remote Reset Button

Press & hold for about 8 seconds

Q2. How to calculate the minimum mounting height of the devices?

In order to maximize the received signal strength of the devices, installers need to minimize the effect of the out-of-phase signals, which is caused by obstacles in the path between the transmitter and the receiver. Fresnel Zone is a usual method to calculate this path, as shown in the formula and the figure below.

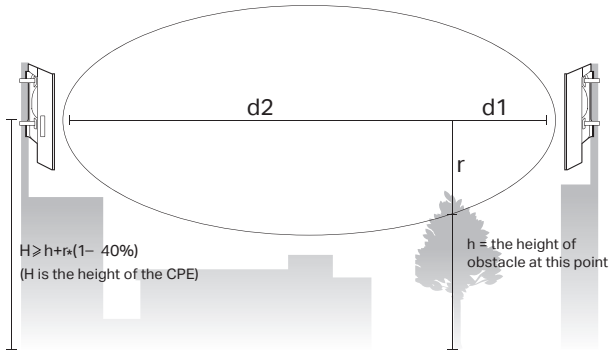

$$r = \sqrt{\frac{d_1 \times d_2}{d_1 + d_2} \cdot \frac{c}{f}}$$

where,

r = Fresnel zone radius in meters

$c = 3 \times 10^8$ m/s, speed of light

f = operating frequency of the devices in Hz

d_1 & d_2 = the distances between the point and the devices in meters

For example, assume d_1 is 2km, d_2 is 8km, and f is 2.4GHz, then r would be 14.142m. Considering a toleration of 40%, allowable radius would be 8.485m. Assume h is 10m, then the result of the minimum mounting height based on this point would be 18.485m. Similarly, calculate the results based on all the points where there are obstacles, and the maximum value would be the final result.

For more information, please refer to:

http://en.wikipedia.org/wiki/Fresnel_zone

Q3. What is Pharos MAXstream?

Pharos MAXstream is a proprietary protocol developed on the basis of Time Division Multiple Access (TDMA) by TP-Link.

The MAXstream technology has the following advantages:

- Eliminates hidden node collisions & improves channel efficiency.
- Lower latency, higher throughput, larger network capacity & more stability.
- Improves the QoS for video, voice and sound data stream.

By dividing the timing of transmission into different time slots, MAXstream allows the Pharos devices to transmit in rapid succession, one after another, each using its own time slot to transmit and receive their own frames, which greatly reduces the chance of collision.

Pharos MAXstream is a non-standard Wi-Fi protocol that is only compatible with TP-Link's Pharos series products. Please notice that you will not be able to connect other Wi-Fi devices to an AP with MAXstream enabled.

Q4. How can I use Spectrum Analysis to find the appropriate channel for the devices?

1. Log in to PharOS, click **Spectrum Analysis** in the tools drop-down list, a window will pop up to remind you that all wireless connections will be lost during spectrum analysis. Click **Yes** to continue to the Spectrum Analysis page.

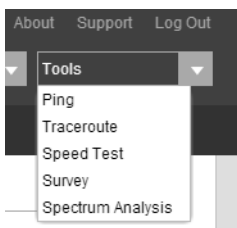

2. Click **Start**, the PharOS will begin to analyze the power of frequency. Observe the curves for a period of time, and then click **Stop**. Note that the relatively low and continuous part of the

average curve indicates less radio noise. Here, we use the figure below as an example.

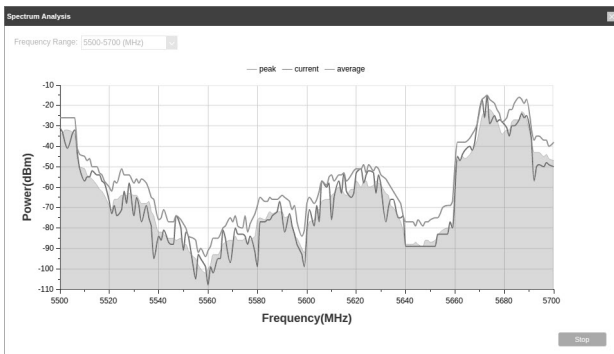

 The select box of Frequency Range at the top-left corner is only available for CPE510 and CPE520. Select the desired range and then click Start.

When choosing channel/frequency, you should avoid the spectrum with large radio noise. In this example, the recommended channel/frequency is 112/5560MHz.

FCC STATEMENT (For CPE220/CPE510/CPE520)

This equipment has been tested and found to comply with the limits for a Class A digital device, pursuant to part 15 of the FCC Rules. These limits are designed to provide reasonable protection against harmful interference when the equipment is operated in a commercial environment. This equipment generates, uses, and can radiate radio frequency energy and, if not installed and used in accordance with the instruction manual, may cause harmful interference to radio communications. Operation of this equipment in a residential area is likely to cause harmful interference in which case the user will be required to correct the interference at his own expense.

This device complies with part 15 of the FCC Rules. Operation is subject to the following two conditions:

- 1) This device may not cause harmful interference.
- 2) This device must accept any interference received, including interference that may cause undesired operation.

Any changes or modifications not expressly approved by the party responsible for compliance could void the user's authority to operate the equipment.

Note: The manufacturer is not responsible for any radio or TV interference caused by unauthorized modifications to this equipment. Such modifications could void the user's authority to operate the equipment.

FC (For CPE210)

This equipment has been tested and found to comply with the limits for a Class B digital device, pursuant to part 15 of the FCC Rules. These limits are designed to provide reasonable protection against harmful interference in a residential installation. This equipment generates, uses and can radiate radio frequency energy and, if not installed and used in accordance with the instructions, may cause harmful interference to radio communications. However, there is no guarantee that interference will not occur in a particular installation. If this equipment does cause harmful interference to radio or television reception, which can be determined by turning the equipment off and on, the user is encouraged to try to correct the interference by one or more of the following measures:

- Reorient or relocate the receiving antenna.
- Increase the separation between the equipment and receiver.
- Connect the equipment into an outlet on a circuit different from that to which the receiver is connected.
- Consult the dealer or an experienced radio/ TV technician for help.

This device complies with part 15 of the FCC Rules. Operation is subject to the following two conditions:

- 1) This device may not cause harmful interference.
- 2) This device must accept any interference received, including interference that may cause undesired operation.

Any changes or modifications not expressly approved by the party responsible for compliance could void the user's authority to operate the equipment.

Note: The manufacturer is not responsible for any radio or TV interference caused by unauthorized modifications to this equipment. Such modifications could void the user's authority to operate the equipment.

FCC RF Radiation Exposure Statement:

This equipment complies with FCC RF radiation exposure limits set forth for an uncontrolled environment. This device and its antenna must not be co-located or operating in conjunction with any other antenna or transmitter.

"To comply with FCC RF exposure compliance requirements, this grant is applicable to only Mobile Configurations. The antennas used for this transmitter must be installed to provide a separation distance of at least 20 cm from all persons and must not be co-located or operating in conjunction with any other antenna or transmitter."

CE Mark Warning



For CPE220/CPE510/CPE520:

This is a Class A product. In a domestic environment, this product may cause radio interference, in which case the user may be required to take adequate measures.

For CPE210:

This is a Class B product. In a domestic environment, this product may cause radio interference, in which case the user may be required to take adequate measures.

OPERATING FREQUENCY(the maximum transmitted power)

2412MHz—2472MHz(20dBm) (CPE210/CPE220)

5500MHz—5700MHz(27dBm) (CPE510/CPE520)

EU declaration of conformity

TP-Link hereby declares that the device is in compliance with the essential requirements and other relevant provisions of directives 2014/53/EU, 2009/125/EC and 2011/65/EU.

The original EU declaration of conformity may be found at <http://www.tp-link.com/en/ce>

RF Exposure Information

This device meets the EU requirements (2014/53/EU Article 3.1a) on the limitation of exposure of the general public to electromagnetic fields by way of health protection.

The device complies with RF specifications when the device used at 20 cm from your body.

Canadian Compliance Statement

This device complies with Industry Canada license-exempt RSSs. Operation is subject to the following two conditions:

- 1) This device may not cause interference, and
- 2) This device must accept any interference, including interference that may cause undesired operation of the device.

Le présent appareil est conforme aux CNR d'Industrie Canada applicables aux appareils radio exempts de licence. L'exploitation est autorisée aux deux conditions suivantes :

- 1) l'appareil ne doit pas produire de brouillage;
- 2) l'utilisateur de l'appareil doit accepter tout brouillage radioélectrique subi, même si le brouillage est susceptible d'en compromettre le fonctionnement.

Caution: (For CPE510/CPE520)

- 1) The device for operation in the band 5150–5250 MHz is only for indoor use to reduce the potential for harmful interference to co-channel mobile satellite systems;
- 2) For devices with detachable antenna(s), the maximum antenna gain permitted for devices in the bands 5250-5350 MHz and 5470-5725 MHz shall be such that the equipment still complies with the e.i.r.p. limit;
- 3) For devices with detachable antenna(s), the maximum antenna gain permitted for devices in the band 5725-5850 MHz shall be such that the equipment still complies with the e.i.r.p. limits specified for point-to-point and non-point-to-point operation as appropriate; and

The high-power radars are allocated as primary users (i.e. priority users) of the bands 5250-5350 MHz and 5650-5850 MHz and that these radars could cause interference and/or damage to LE-LAN devices.

DFS (Dynamic Frequency Selection) products that operate in the bands 5250- 5350 MHz, 5470-5600MHz, and 5650-5725MHz.

Avertissement: (For CPE510/CPE520)

- 1) Le dispositif fonctionnant dans la bande 5150-5250 MHz est réservé uniquement pour une utilisation à l'intérieur afin de réduire les risques de brouillage préjudiciable aux systèmes de satellites mobiles utilisant les mêmes canaux;
- 2) Le gain maximal d'antenne permis pour les dispositifs avec antenne(s) amovible(s) utilisant les bandes 5250-5350 MHz et 5470-5725 MHz doit se conformer à la limitation P.I.R.E.;
- 3) Le gain maximal d'antenne permis pour les dispositifs avec antenne(s) amovible(s) utilisant la bande 5725-5850 MHz doit se conformer à la limitation P.I.R.E. spécifiée pour l'exploitation point à point et non point à point, selon le cas.

En outre, les utilisateurs devraient aussi être avisés que les utilisateurs de radars de haute puissance sont désignés utilisateurs principaux (c.-à-d., qu'ils ont la priorité) pour les bandes 5250-5350 MHz et 5650-5850 MHz et que ces radars pourraient causer du brouillage et/ou des dommages aux dispositifs LAN-EL.

Les produits utilisant la technique d'atténuation DFS (sélection dynamique des fréquences) sur les bandes 5250- 5350 MHz, 5470-5600MHz et 5650-5725MHz.

Radiation Exposure Statement:

This equipment complies with IC radiation exposure limits set forth for an uncontrolled environment. This equipment should be installed and operated with minimum distance 20cm between the radiator & your body.

Déclaration d'exposition aux radiations:

Cet équipement est conforme aux limites d'exposition aux rayonnements IC établies pour un environnement non contrôlé. Cet équipement doit être installé et utilisé avec un minimum de 20 cm de distance entre la source de rayonnement et votre corps.

Radiation Exposure Statement: (For CPE220)

This equipment complies with IC radiation exposure limits set forth for an uncontrolled environment. This equipment should be installed and operated with minimum distance 39cm between the radiator & your body.

Déclaration d'exposition aux radiations: (For CPE220)

Cet équipement est conforme aux limites d'exposition aux rayonnements IC établies pour un environnement non contrôlé. Cet équipement doit être installé et utilisé avec un minimum de 39 cm de distance entre la source de rayonnement et votre corps.

Industry Canada Statement (For CPE220/CPE510/CPE520)

CAN ICES-3 (A)/NMB-3(A)

Industry Canada Statement (For CPE210)

CAN ICES-3 (B)/NMB-3(B)



Safety Information

- Keep the device away from water, fire, humidity or hot environments.
- Do not attempt to disassemble, repair, or modify the device.
- Do not use damaged charger or USB cable to charge the device.
- Do not use any other chargers than those recommended
- Do not use the device where wireless devices are not allowed.
- Adapter shall be installed near the equipment and shall be easily accessible.



Use only power supplies which are provided by manufacturer and in the original packing of this product. If you have any questions, please don't hesitate to contact us.

Please read and follow the above safety information when operating the device. We cannot guarantee that no accidents or damage will occur due to improper use of the device. Please use this product with care and operate at your own risk.

NCC Notice & BSMI Notice

注意!

依據 低功率電波輻射性電機管理辦法

第十二條 經型式認證合格之低功率射頻電機，非經許可，公司、商號或使用者均不得擅自變更頻率、加大功率或變更原設計之特性或功能。

第十四條 低功率射頻電機之使用不得影響飛航安全及干擾合法通行；經發現有干擾現象時，應立即停用，並改善至無干擾時方得繼續使用。前項合法通信，指依電信規定作業之無線電信。低功率射頻電機需忍受合法通信或工業、科學以及醫療用電波輻射性電機設備之干擾。

安全諮詢及注意事項



- 請使用原裝電源供應器或只能按照本產品注明的電源類型使用本產品。
- 清潔本產品之前請先拔掉電源線。請勿使用液體、噴霧清潔劑或濕布進行清潔。
- 注意防潮，請勿將水或其他液體潑灑到本產品上。
- 插槽與開口供通風使用，以確保本產品的操作可靠並防止過熱，請勿堵塞或覆蓋開口。
- 請勿將本產品置放於靠近熱源的地方。除非有正常的通風，否則不可放在密閉位置中。
- 請不要私自打開機殼，不要嘗試自行維修本產品，請由授權的專業人士進行此項工作。

(For CPE220/CPE510/CPE520) 此為甲類資訊技術設備，于居住環境中使用時，可能會造成射頻擾動，在此種情況下，使用者會被要求採取某些適當的對策



Продукт сертифіковано згідно с правилами системи УкрСЕПРО на відповідність вимогам нормативних документів та вимогам, що передбачені чинними законодавчими актами України.

Explanation of the symbols on the product label

Symbol	Explanation
	DC voltage
	<p>RECYCLING</p> <p>This product bears the selective sorting symbol for Waste electrical and electronic equipment (WEEE). This means that this product must be handled pursuant to European directive 2012/19/EU in order to be recycled or dismantled to minimize its impact on the environment.</p> <p>User has the choice to give his product to a competent recycling organization or to the retailer when he buys a new electrical or electronic equipment.</p>

(For CPE220/CPE510/CPE520)

この装置は、クラスA情報技術装置です。この装置を家庭環境で使用すると電波妨害を引き起こすことがあります。この場合には使用者が適切な対策を講ずることがあります。

VCCI-A



For technical support and other information, please visit
<http://www.tp-link.com/support>, or simply scan the QR code.

The products of TP-Link partly contain software code developed by third parties, including software code subject to the GNU General Public License ("GPL"). As applicable, the terms of the GPL and any information on obtaining access to the respective GPL Code used in TP-Link products are available to you in GPL-Code-Centre under (<http://www.tp-link.com/en/support/gpl/>). The respective programs are distributed WITHOUT ANY WARRANTY and are subject to the copyrights of one or more authors. For details, see the GPL Code and other terms of the GPL.